

TROUBLESHOOTING
GUIDE ON PAGE 14

CANAKit RASPBERRY PI QUICK-START GUIDE

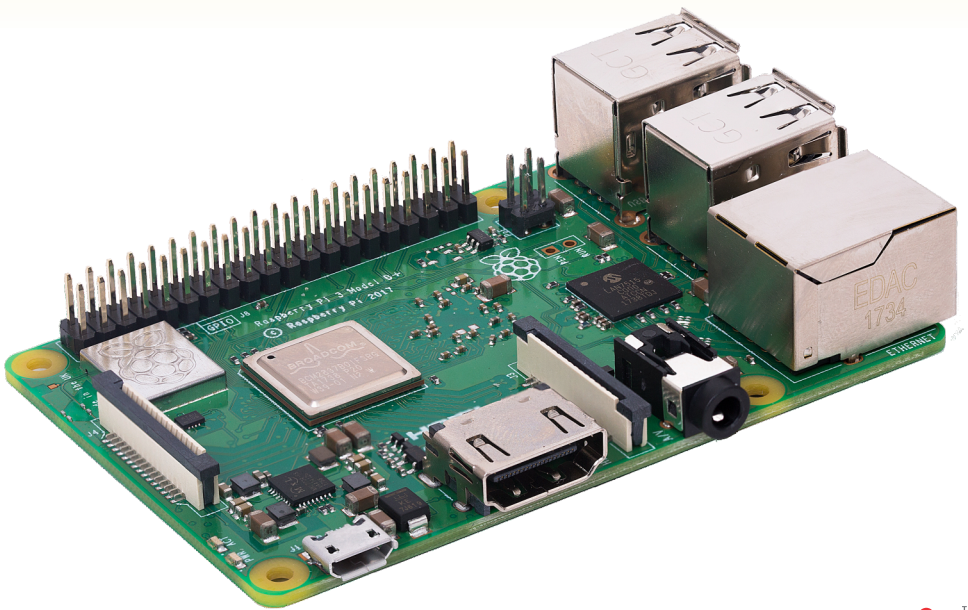

CanaKit[™]

WWW.CANAKIT.COM

WELCOME!

Congratulations on your purchase from CanaKit and welcome to the exciting world of the Raspberry Pi! To setup your Raspberry Pi, you will typically need the following items:

- MicroSD card (pre-loaded with NOOBS* recommended)
- HDMI monitor
- HDMI cable
- USB keyboard and mouse
- 2.5A MicroUSB power adapter
- [Optional] Ethernet cable for connection to a wired network
- [Optional] Case to hold and protect your Raspberry Pi
- [Optional] Set of heat sinks to keep the Raspberry Pi running cool
- [Optional] USB MicroSD card reader for use on your PC or Mac in case you need to re-program the MicroSD card.

**NOOBS is designed to make it easy to select and install operating systems for the Raspberry Pi without having to worry about manually imaging your MicroSD card.*

If you purchased one of CanaKit's Raspberry Pi Starter Kits, it will include many of the above items depending on the specific kit. For a complete selection of CanaKit Raspberry Pi boards, kits and accessories, visit your favorite CanaKit retailer or our website at:

www.canakit.com/raspberry-pi



facebook.com/CanaKitCorp



[@canakit](https://twitter.com/canakit)

CANAKit WARRANTY REGISTRATION

Your purchase comes with a CanaKit Limited Warranty. In order to take advantage of this warranty, you must activate it within 30-days of purchase by registering at:

www.canakit.com/warranty

UPDATES

The Raspberry Pi and corresponding software is constantly evolving with frequent changes and revisions. Therefore, some screen-shots shown in this guide may look different depending on the specific version of the software. For the latest version of this guide, please refer to:

www.canakit.com/pi

SUPPORT & RESOURCES

At CanaKit, we would like to ensure your complete satisfaction. If you purchased a kit from us, please inspect the contents of your kit and do not hesitate to contact us should you have any issues. You can reach us at:

help@canakit.com

To learn more about the Raspberry Pi, refer to the Raspberry Pi Foundation Resources page at:

www.canakit.com/pi-resources

For Raspberry Pi related technical support, a great place to start is the official Raspberry Pi Foundation forums at:

www.canakit.com/pi-forums

GETTING STARTED

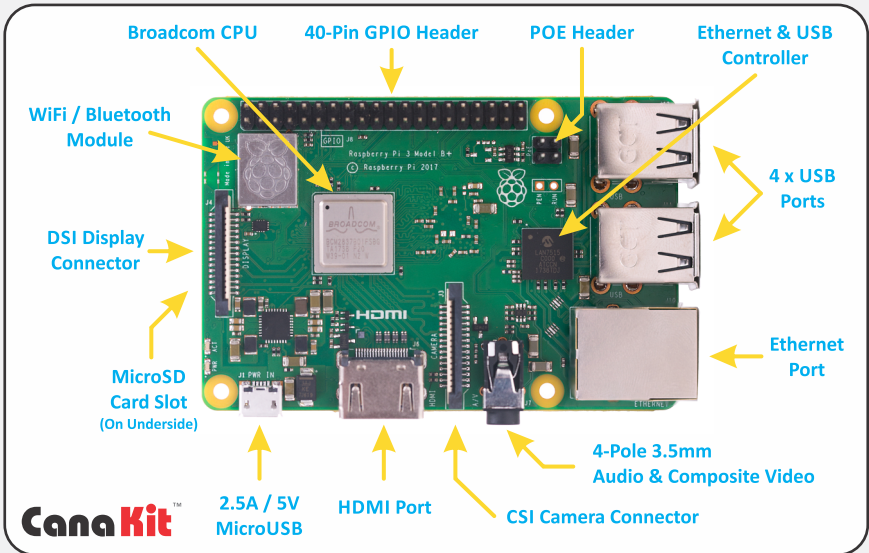

1. If you have a case, start by installing the Raspberry Pi inside the case. To avoid damaging your MicroSD card, do NOT insert the card until the board is installed in the case. You can find video instructions for CanaKit cases at:

www.canakit.com/pi-case

2. Optionally, if you would like to use heat sinks to keep the Raspberry Pi running cool, first peel off the protective film from the bottom of each heat sink and then press each one firmly onto the corresponding chip. The larger heat sink should be placed on the Broadcom CPU and the smaller one on the Ethernet/USB Controller. See figure above for their locations.

3. Insert a MicroSD card pre-loaded with NOOBS into the MicroSD card slot **on the bottom side** of the Raspberry Pi. If you don't have a pre-loaded MicroSD card you can find instructions on how to make one in Appendix 1 and 2 (Page 12 and 13).

4. Connect a USB keyboard and mouse to the USB ports.

5. Connect a HDMI monitor or TV to the Raspberry Pi using a HDMI cable. Ensure your monitor or TV is turned on and the correct input is selected.

6. Once all connections have been made, it is now time to connect the 2.5A power adapter to the board. When the power is connected, the Raspberry Pi will start to boot and you should be presented with the following menu.

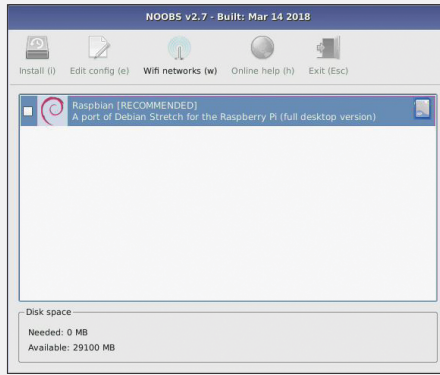

NOTE: If you see a lightning bolt symbol with a rainbow splash screen as shown to the right, it indicates you are not using Pi 3 B+ compatible software. It is NOT related to the voltage of the power supply. Ensure you are using NOOBS 2.7.0 or later.

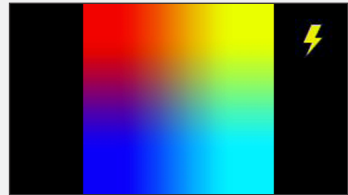

TIP: Once an Operating System has been installed, the NOOBS menu will no longer appear. If you need to get back to the NOOBS menu, press and hold the SHIFT key on your keyboard when turning on the Raspberry Pi.

7. If you intend to use an Operating System other than Raspbian, connect the Raspberry Pi to your network using an ethernet cable. If you have a Raspberry Pi 3 or later, you can also connect to your WiFi network by clicking “Wifi networks”. Once an Internet connection is detected, you will be presented with additional choices of Operating Systems to install.

8. Select “Raspbian” or your choice of Operating System(s) from the menu. Click “Install” to begin the installation process.

9. NOOBS will now start the installation of the selected Operating System(s). This process will take a few minutes and you will see a message indicating the installation has completed. Press OK and the Pi will reboot.

RASPBIAN STRETCH

Stretch is the latest release of Raspbian at the time of writing and it comes loaded with many applications. When Raspbian first starts, it will automatically boot straight to the graphical desktop interface.

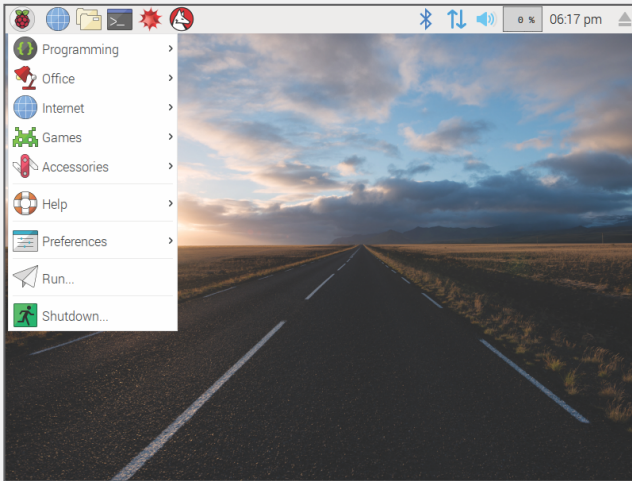

The first time you start your Raspberry Pi, it is recommend to launch the Raspberry Pi Configuration application in order to set system configuration parameters, such as default WiFi Country (required for WiFi operation), Password, Hostname, Locale, Timezone and Keyboard Layout. This tool can be found under the Preferences entry under the Main Menu.

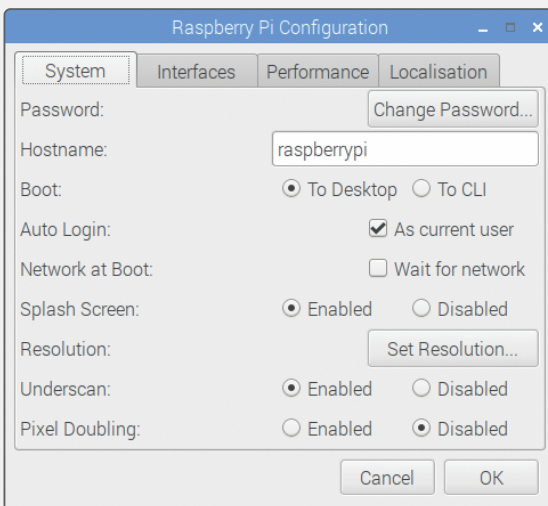

SHUTTING DOWN THE RASPBERRY PI

Like any computer, it is very important that the Raspberry Pi be shutdown properly so that the MicroSD card File System is not corrupted. If you are in the graphical desktop interface, you can simply click “Menu” and then select “Shutdown”. On the other hand, if you are in the command line interface, you can type the following command:

```
sudo shutdown -h now
```

RASPBIAN WIFI CONFIGURATION

If you have a Raspberry Pi 3 or later (or if you have an older Raspberry Pi with a compatible WiFi adapter), the easiest way to configure it is through the graphical desktop interface.

You may connect to a WiFi network by clicking on the network icon on the top right of the desktop. This should bring up a list of available WiFi networks.

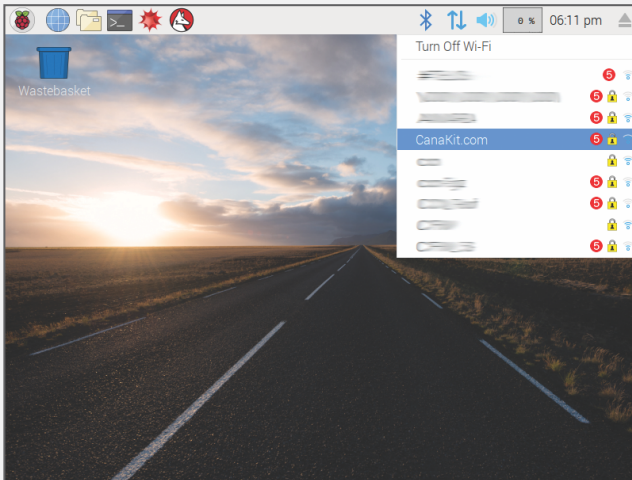

Select your desired network and you will be prompted for the network password. Once a successful connection is made, the network icon will change to a WiFi signal icon. Clicking the icon will now show the currently selected network with a green checkmark besides it. Hovering the mouse over the icon will show your current IP address.

GETTING STARTED WITH ELECTRONICS

As well as being a fully functional computer, the Raspberry Pi is a great tool to introduce yourself to the world of electronics. Through the use of the General Purpose Input/Output (GPIO) port of the Raspberry Pi, you can connect to the external world and create electronic projects very easily.

Two simple examples are shown in this guide to get you started. The first example allows the Raspberry Pi to simply blink an LED. The second example allows the Raspberry Pi to control an LED through a push-button switch. For these examples, you will require the following components:

- Small prototyping breadboard
- 4 pieces of male-to-female jumper wires
- 1 piece of male-to-male jumper wire
- An LED
- A 220 Ohm Resistor
- A 10K Ohm Resistor
- A push-button switch

If you purchased a kit such as the CanaKit Raspberry Pi Ultimate Kit, you will already have these components; otherwise, they can be purchased separately from your favorite CanaKit retailer.

IMPORTANT NOTES

You must shut down your Raspberry Pi and disconnect the power before making any connections between the GPIO port and your electronic circuit. Failure to do so can damage your Raspberry Pi.

Care must be taken to ensure the electronic circuit that you connect to the Raspberry Pi is correct and all connections are done with correct polarity. Failure to connect electronic circuits properly to the GPIO port can damage your Raspberry Pi. It is therefore important to double check all connections before applying power to the Raspberry Pi.

GPIO PORT AND PYTHON

The General Purpose Input/Output (GPIO) port of the Raspberry Pi can be controlled in various ways but the examples in this guide will use the Python 2 programming language. In order to run the code for each example, follow these steps:

1. From the main menu in Raspbian, choose Programming -> Python 2 (IDLE).
2. From the File menu, select "New File". This will open up a new window where you can type the code required for each example.
3. Once you have typed the example code, from the Run menu, select "Run Module".

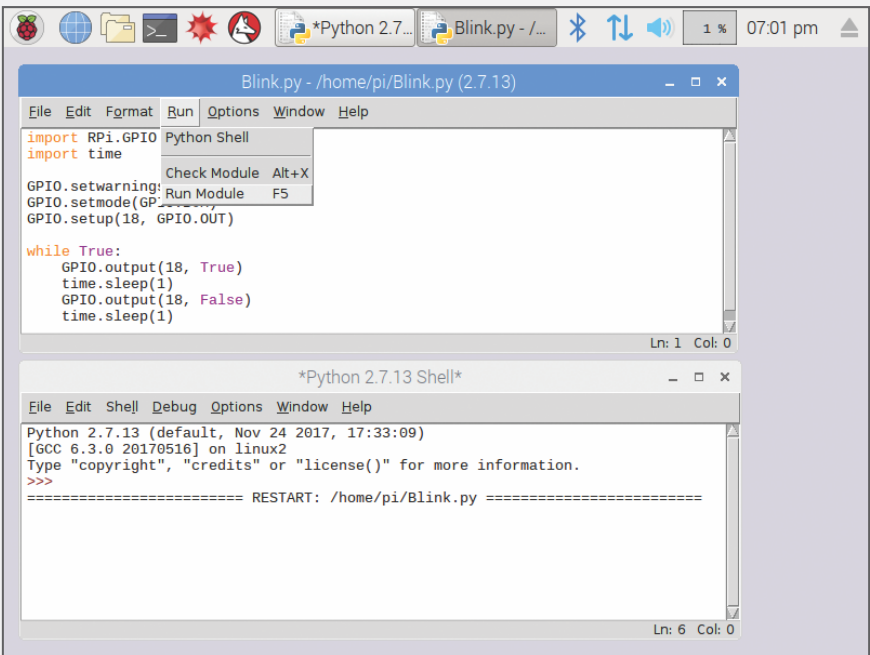

If this is the first time you are running the module, you will be prompted to save the file. If there were no errors in your code, the program will now be executed.

BLINKING AN LED

To blink an LED, use three male-to-female jumper wires and a 220 Ohm resistor (red, red, brown) to connect the LED to the GPIO port as shown below.

Note that it is important for the LED to be connected with correct polarity or it will not light up and you may damage the LED. The longer leg of an LED is called the Anode (+) and the shorter leg is called the Cathode (-). In this example, the shorter leg (Cathode) is to be connected to the resistor.

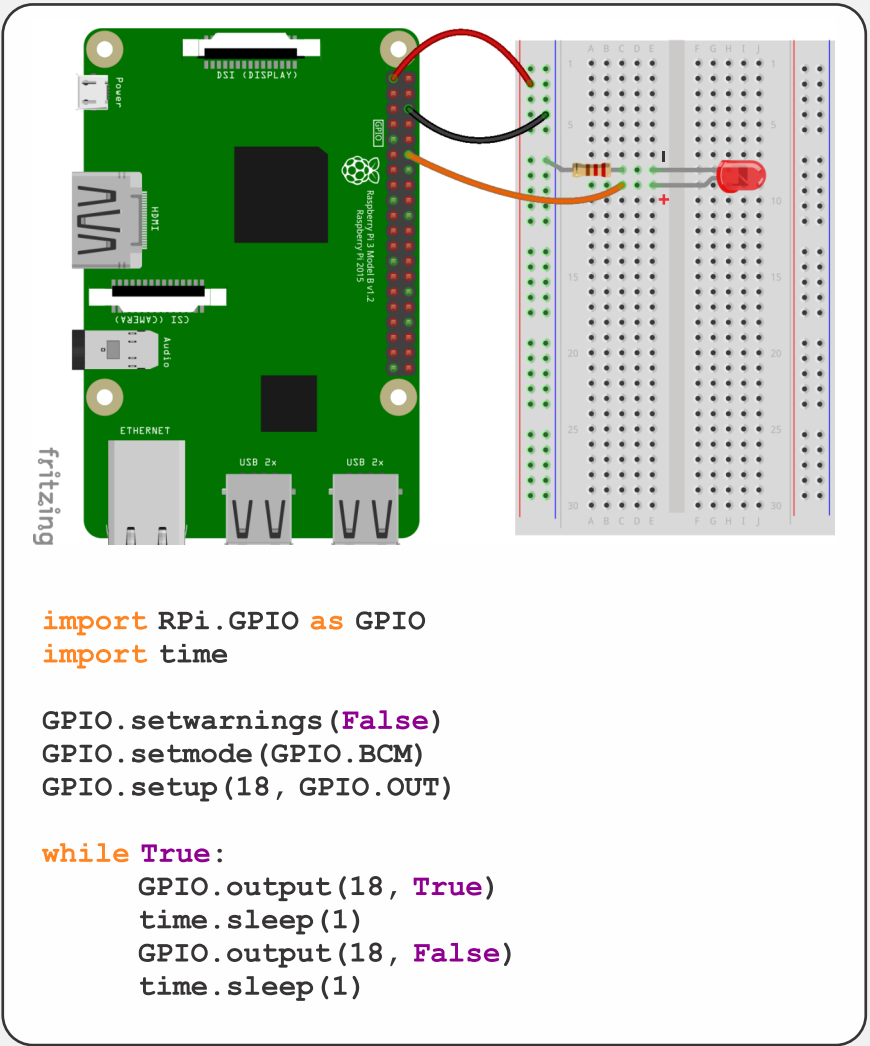

```
import RPi.GPIO as GPIO
import time

GPIO.setwarnings(False)
GPIO.setmode(GPIO.BCM)
GPIO.setup(18, GPIO.OUT)

while True:
    GPIO.output(18, True)
    time.sleep(1)
    GPIO.output(18, False)
    time.sleep(1)
```

CONTROLLING THE LED WITH A BUTTON

This example builds upon the previous example by adding a push-button switch that will control the LED. Use an additional male-to-female jumper wire, a male-to-male jumper wire, and a 10K Ohm resistor (brown, black, orange) to connect the push-button switch to the GPIO port.

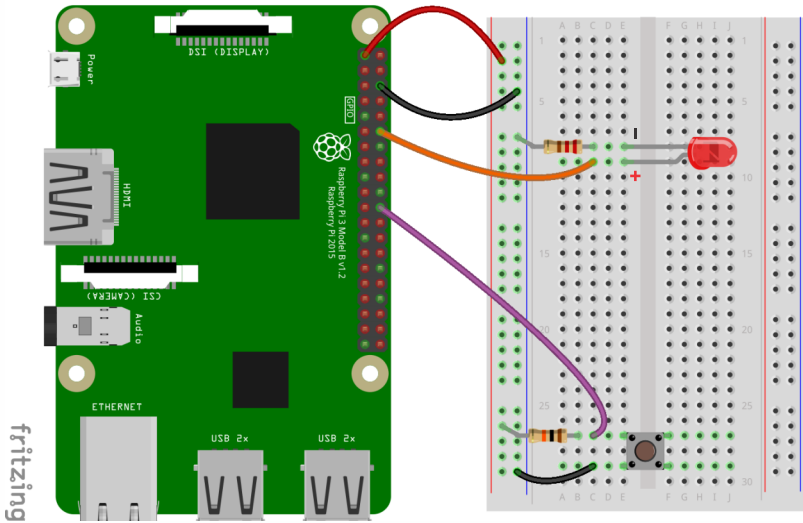

```
import RPi.GPIO as GPIO
import time

GPIO.setwarnings(False)
GPIO.setmode(GPIO.BCM)
GPIO.setup(18, GPIO.OUT)
GPIO.setup(25, GPIO.IN)

while True:
    if GPIO.input(25):
        GPIO.output(18, False)
    else:
        GPIO.output(18, True)
```

MORE PROJECTS

For more projects using the Raspberry Pi GPIO port, please visit:

www.canakit.com/pi-projects

GPIO REFERENCE

Use the guide below to easily identify each of the 40-pins of the GPIO port.

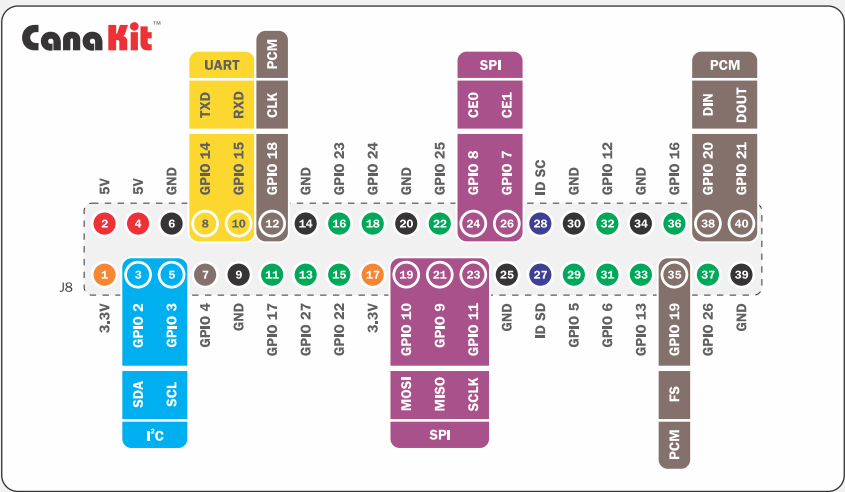

APPENDIX 1 – INSTALLING NOOBS TO A MICROSD CARD

NOOBS (New Out Of Box Software) is an operating system installation manager for the Raspberry Pi and is designed to make it easy to install select operating systems for the Raspberry Pi without having to worry about manually imaging your MicroSD card.

If you don't have a pre-installed NOOBS MicroSD card, or if you need to re-install NOOBS, follow the instructions below.

To install NOOBS to a MicroSD card, first you must ensure the memory card is properly formatted. If using Windows, ensure to format the MicroSD card using the correct tool as follows:

- When formatting cards 32 GB or smaller, use the tool called “SD Memory Card Formatter” found at:

www.canakit.com/tools/sdformatter

- When formatting cards 64 GB or larger, use the tool called “FAT32 Format” found at:

www.canakit.com/tools/fat32format

On Linux or Mac OS you can use the standard formatting tools already built-in. On a Mac, this means using the Disk Utility application.

When formatting, always ensure the correct drive is selected so that you do not accidentally format a different drive.

Once the MicroSD card is formatted properly, download, unzip and simply copy-paste **the contents inside** the NOOBS ZIP file onto the MicroSD card. You can download the latest version of NOOBS at:

www.canakit.com/downloads/noobs

APPENDIX 2 – IMAGING A MICROSD CARD

If you would like to install an operating system image that is not available through NOOBS, the easiest way is to use a great utility called Etcher to image your MicroSD card. Etcher is available for Windows, Mac and Linux.

1. Download and install the appropriate version of Etcher from:

www.canakit.com/tools/etcher

2. Download your OS image. Care must be given to ensure you download an OS image compatible with your specific Raspberry Pi board version. For example, an OS image designed for the Raspberry Pi 3 may not work on a Raspberry Pi 3 B+.

3. Run Etcher and select the OS image you downloaded.

4. Attach your MicroSD card to your computer. Etcher should detect it and select it automatically, **but ensure the correct drive is selected.**

5. Click Flash. Etcher will automatically format the card before writing and verifying the image.

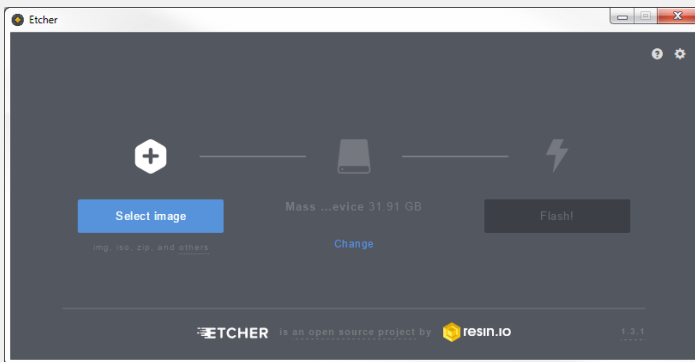

TROUBLESHOOTING

Problem: I am using a Raspberry Pi 3 B+. I see a lightning bolt symbol with a rainbow splash screen and it does not boot.

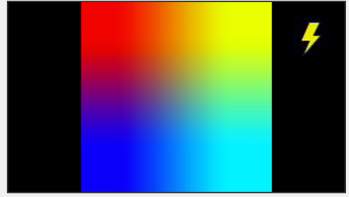

Solution: This is an indication that the software being used is NOT compatible with the Pi 3 B+. It is not related to any voltage issues with the power supply. Note that if you take your SD card from a Pi 3 B and use it on the Pi 3 B+, it would not boot unless proper updates are done first. Please ensure to use the latest version of NOOBS (2.7.0 or later) so that you are using Pi 3 B+ compatible software.

Problem: I see the red power light illuminated on the board, but there is no other activity and nothing is displayed on my screen.

Solution: First check that the MicroSD card is fully seated all the way in the MicroSD card slot of the Raspberry Pi board itself. Note that the device may NOT be able to boot if using the card through a USB card reader dongle plugged into a USB port.

Second, ensure the card is properly formatted with compatible software such as NOOBS as explained in Appendix 1 (Page 12) , or another compatible operating system as explained in Appendix 2 (Page 13) in order to be able to boot.

Problem: The device is working normally and I am using a 2.5A adapter but I occasionally see a lightning bolt symbol.

Solution: This is usually caused by using a low quality in-line switch or a case that has a built-in switch creating a voltage drop. Removing the in-line switch or changing to a case without a switch would typically resolve this problem.

If you have a problem not listed above, please visit www.canakit.com/pi for more troubleshooting guides or email us for assistance:

help@canakit.com

GET THE OFFICIAL RASPBERRY PI MAGAZINE

The
MagPi
raspberrypi.org/magpi Magazine



SUBSCRIBE
TODAY
FROM JUST **\$69**

AND RECEIVE A
FREE PI ZERO

Pi Zero available with 6 & 12 month subscriptions, while stocks last



Subscriber benefits:

- Save up to 25% on the cover price
- Get every issue before stores
- Free Pi Zero & cable bundle
- Free delivery to your home

Visit: www.canakit.com/magpi



X O J O

Powerful app development
for Raspberry Pi!

Register your CanaKit and
get a FREE* Xojo license
(\$49 value) at:

www.canakit.com/register

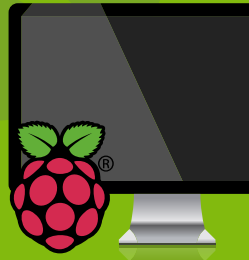

* While quantities last

© 2018 Cana Kit Corporation. All Rights Reserved.

Raspberry Pi and the Raspberry Pi Logo are trademarks of the Raspberry Pi Foundation. CanaKit is a registered trademark of Cana Kit Corporation. This manual is copyright of Cana Kit Corporation. All other trademarks or registered trademarks are property of their respective owners. No part of this manual may be sold, licensed, transferred, copied or reproduced in whole or in part in any manner or form in or on any media without the prior written consent of Cana Kit Corporation.

CanaKitTM

Revision 3.2

WWW.CANAKIT.COM